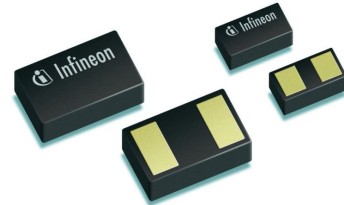
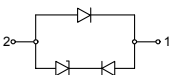

Ultra-Low Capacitance TVS Diode

- ESD / transient protection of high-speed data lines exceeding
IEC61000-4-2 (ESD): ± 20 kV (air / contact)
IEC61000-4-4 (EFT): 2.5 kV/50 A (5/50 ns)
IEC61000-4-5 (surge): 3 A (8/20 μ s)
- Extremely small form factor down to 0.62 x 0.32 x 0.31 mm³
- Max. working voltage: 3.3 V
- Very low reverse current: < 1 nA typ.
- Extremely low capacitance: 0.4 pF typ.
- Very low clamping voltage: 12 V typ. at positive transients, 4 V typ. at negative transients
- Very low series inductance down to 0.2 nH typ.
- Pb-free (RoHS compliant) package
- Qualified according AEC Q101

Applications

- USB 2.0, 10/100/1000 Ethernet, Firewire, DVI, HDMI, S-ATA
- Mobile communication
- Consumer products (STB, MP3, DVD, DSC...)
- LCD displays, camera
- Notebooks and desktop computers, peripherals

ESD3V3U1U-02LS
ESD3V3U1U-02LRH

Type	Package	Configuration	Marking
ESD3V3U1U-02LRH	TSLP-2-7	1 line, uni-directional	E3
ESD3V3U1U-02LS	TSSLP-2-1	1 line, uni-directional	Z

Maximum Ratings at $T_A = 25^\circ\text{C}$, unless otherwise specified

Parameter	Symbol	Value	Unit
ESD (air / contact) discharge ¹⁾	V_{ESD}	20	kV
Peak pulse current ($t_p = 8 / 20 \mu\text{s}$) ²⁾	I_{pp}	3	A
Operating temperature range	T_{op}	-55...125	°C
Storage temperature	T_{stg}	-65...150	

Electrical Characteristics at $T_A = 25^\circ\text{C}$, unless otherwise specified

Parameter	Symbol	Values			Unit
		min.	typ.	max.	
Characteristics					
Reverse working voltage	V_{RWM}	-	-	3.3	V
Breakdown voltage $I_{\text{(BR)}} = 1 \text{ mA}$, from pin 1 to 2	$V_{\text{(BR)}}$	5	-	-	
Reverse current $V_{\text{R}} = 3.3 \text{ V}$, from pin 1 to 2	I_{R}	-	< 1	50	nA
Clamping voltage $I_{\text{PP}} = 1 \text{ A}$, $t_p = 8/20 \mu\text{s}^2$, from pin 1 to 2 $I_{\text{PP}} = 3 \text{ A}$, $t_p = 8/20 \mu\text{s}^2$, from pin 1 to 2	V_{CL}	-	10 12	13 15	V
Forward clamping voltage $I_{\text{PP}} = 1 \text{ A}$, $t_p = 8/20 \mu\text{s}^2$, from pin 2 to 1 $I_{\text{PP}} = 3 \text{ A}$, $t_p = 8/20 \mu\text{s}^2$, from pin 2 to 1	V_{FC}	-	2 4	4 6	
Line capacitance ³⁾ $V_{\text{R}} = 0 \text{ V}$, $f = 1 \text{ MHz}$	C_{T}	-	0.4	0.6	
Series inductance ESD3V3U1U-02LS ESD3V3U1U-02LRH	L_{S}	-	0.2 0.4	-	nH

¹⁾ V_{ESD} according to IEC61000-4-2

²⁾ I_{pp} according to IEC61000-4-5

³⁾Total capacitance line to ground

Clamping voltage, $V_{cl} = f(I_{pp})$

$t_p = 8 / 20 \mu s$, from pin 1 to 2

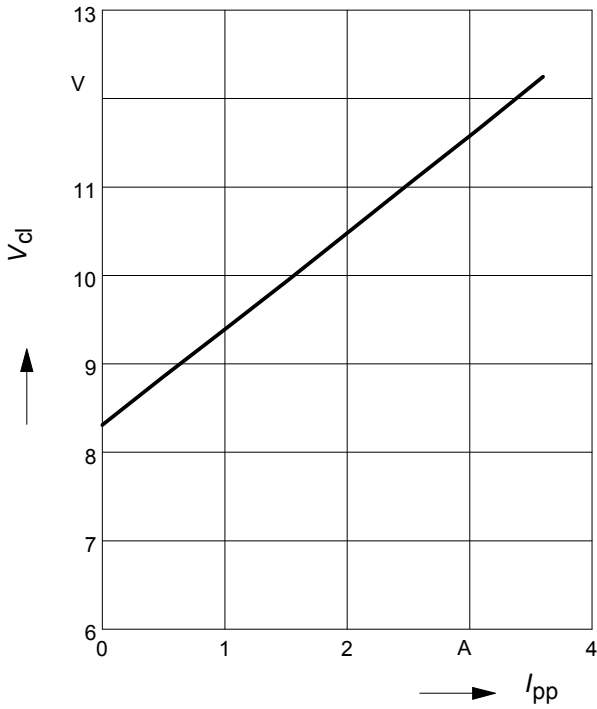

Forward clamping voltage $V_{FC} = f(I_{PP})$

$t_p = 8 / 20 \mu s$, from pin 2 to 1

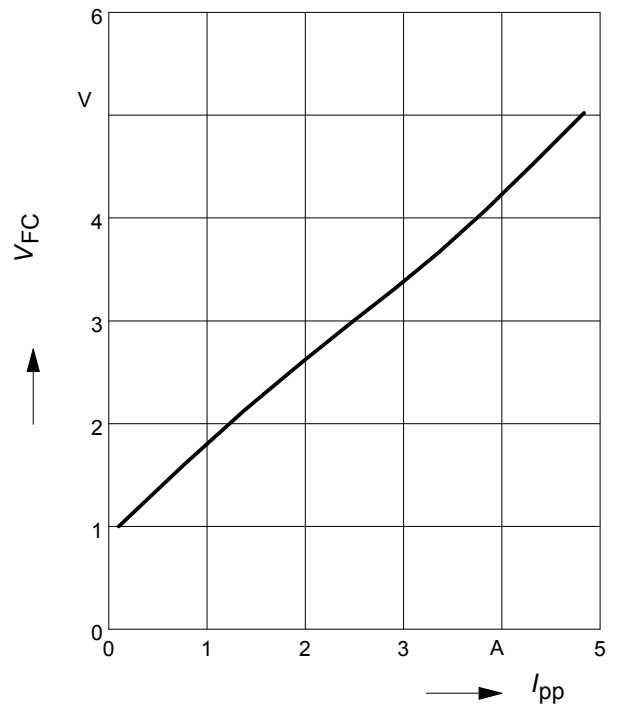

Reverse current $I_R = f(T_A)$

$V_R = 3.3 V$, from pin 1 to 2

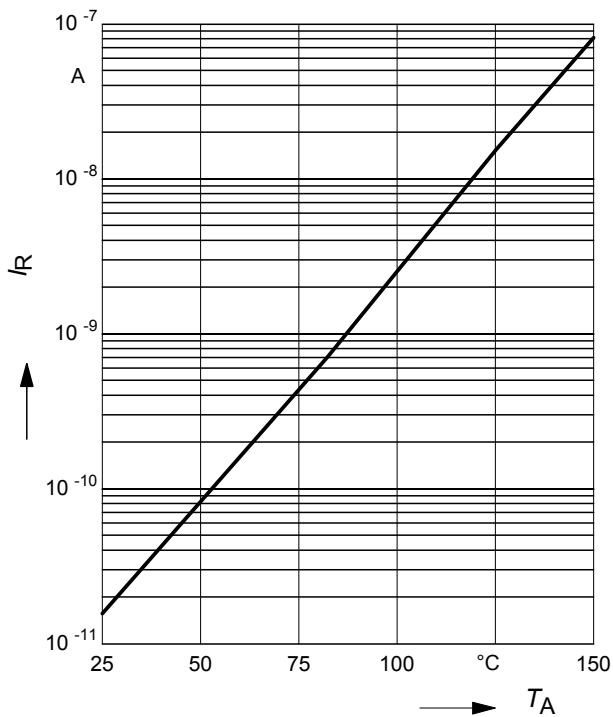

Line capacitance $C_T = f(V_R)$

$f = 1 MHz$, from pin 1 to 2

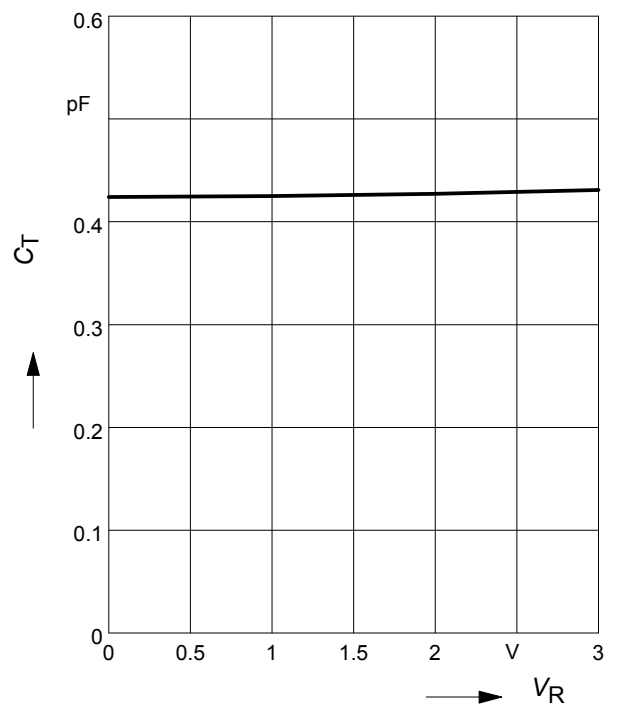

Line capacitance $C_T = f(f)$

$V_R =$ parameter, from pin 1 to 2

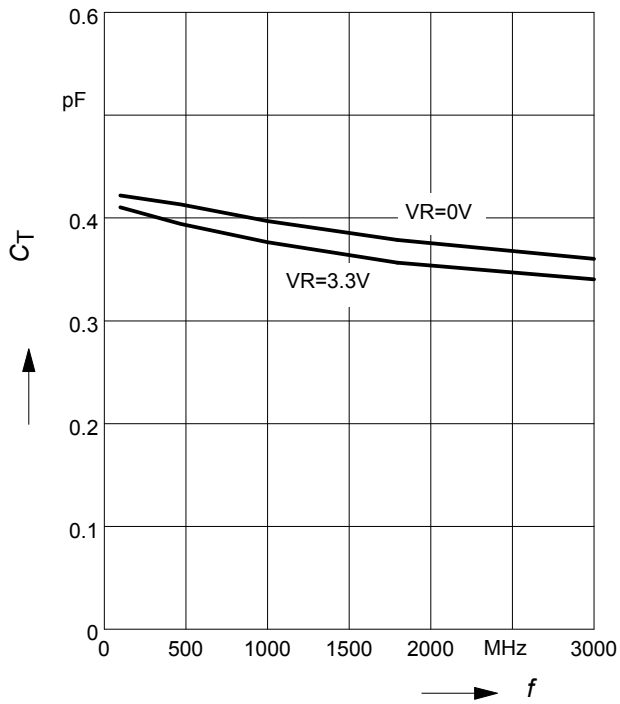

Line capacitance $C_T = f(T_A)$

$V_R = 0V, f = 1\text{ MHz}$

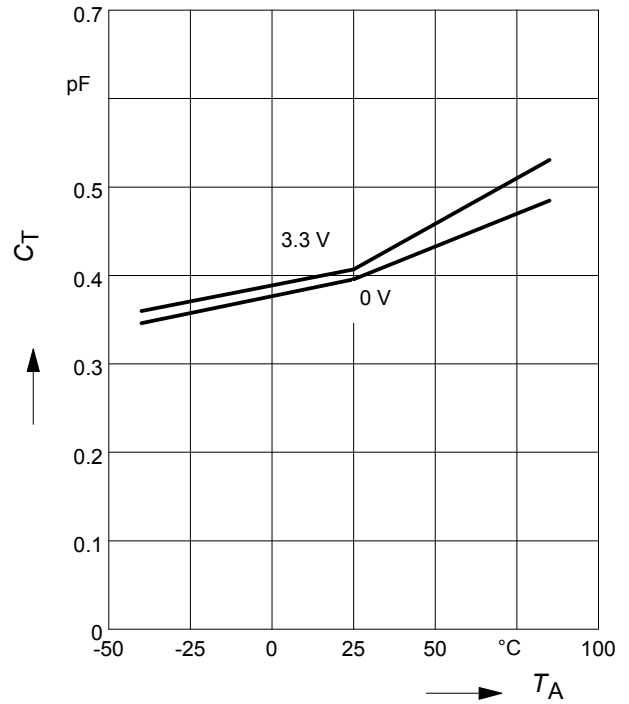

Application example ESD3V3U1U...

1-channel, uni-directional

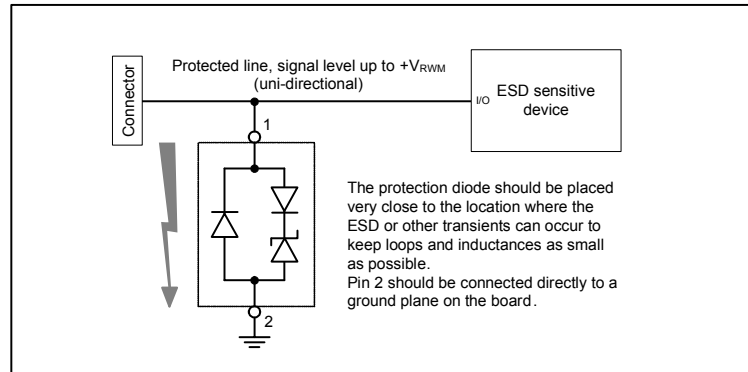

Package Outline

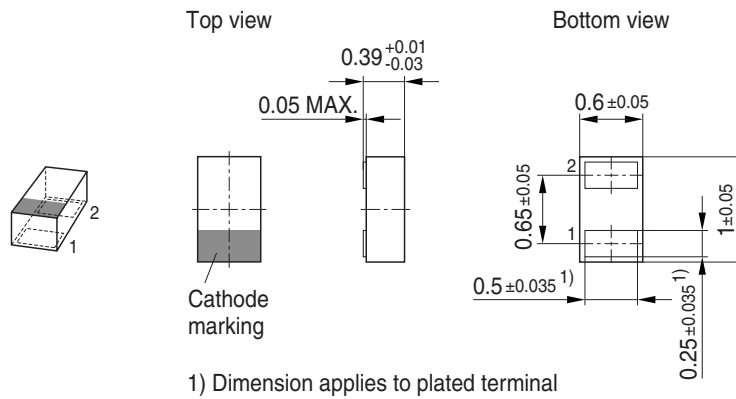

Foot Print

For board assembly information please refer to Infineon website "Packages"

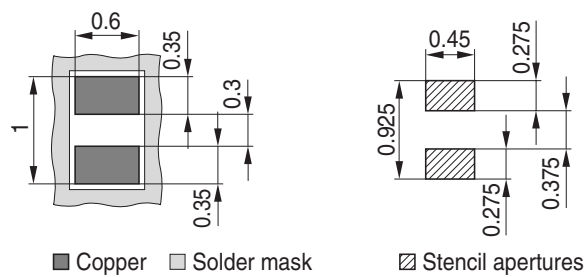

Marking Layout (Example)

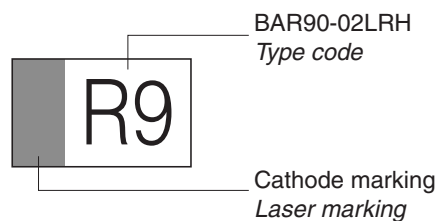

Standard Packing

Reel $\varnothing 180 \text{ mm} = 15.000 \text{ Pieces/Reel}$
 Reel $\varnothing 330 \text{ mm} = 50.000 \text{ Pieces/Reel (optional)}$

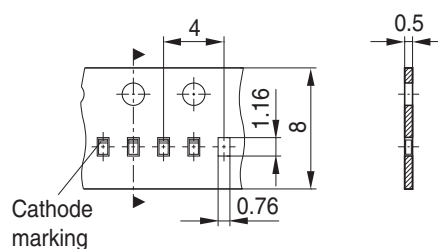

Package Outline

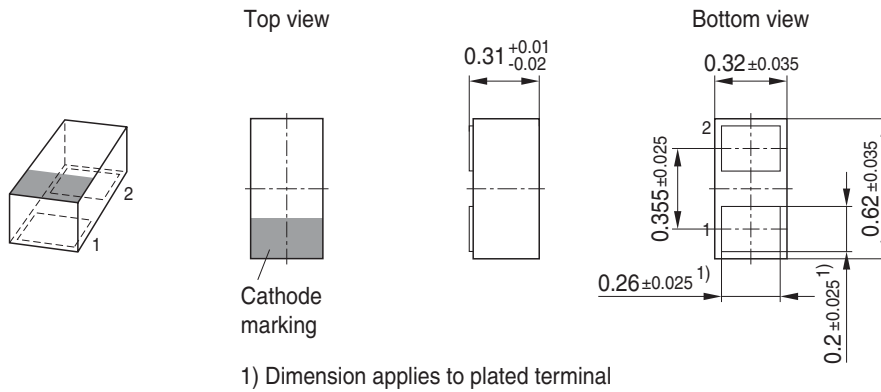

Foot Print

For board assembly information please refer to Infineon website "Packages"

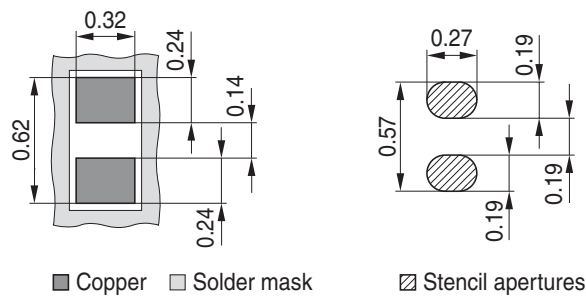

Marking Layout

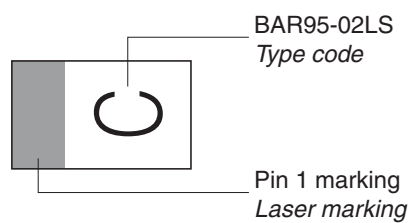

Standard Packing

Reel ø180 mm = 15.000 Pieces/Reel

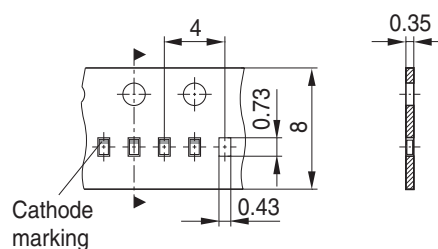

Edition 2006-02-01

Published by

Infineon Technologies AG

81726 München, Germany

© Infineon Technologies AG 2007.

All Rights Reserved.

Attention please!

The information given in this dokument shall in no event be regarded as a guarantee of conditions or characteristics ("Beschaffenheitsgarantie"). With respect to any examples or hints given herein, any typical values stated herein and/or any information regarding the application of the device, Infineon Technologies hereby disclaims any and all warranties and liabilities of any kind, including without limitation warranties of non-infringement of intellectual property rights of any third party.

Information

For further information on technology, delivery terms and conditions and prices please contact your nearest Infineon Technologies Office (www.infineon.com).

Warnings

Due to technical requirements components may contain dangerous substances. For information on the types in question please contact your nearest Infineon Technologies Office.

Infineon Technologies Components may only be used in life-support devices or systems with the express written approval of Infineon Technologies, if a failure of such components can reasonably be expected to cause the failure of that life-support device or system, or to affect the safety or effectiveness of that device or system.

Life support devices or systems are intended to be implanted in the human body, or to support and/or maintain and sustain and/or protect human life. If they fail, it is reasonable to assume that the health of the user or other persons may be endangered.